

 (10)

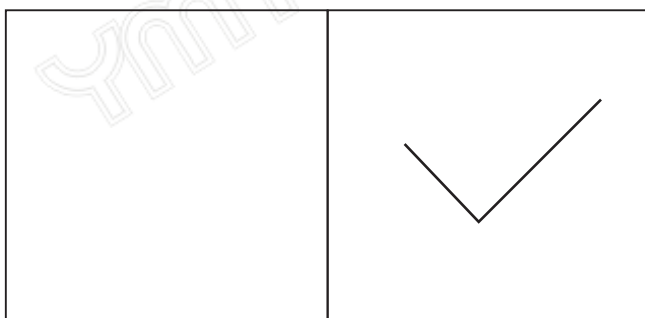

 ()

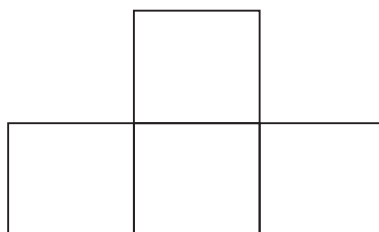
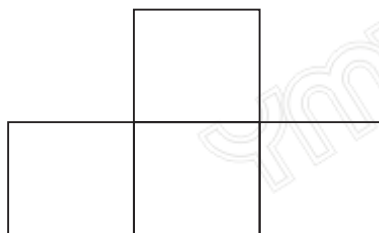
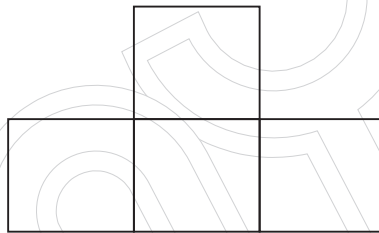
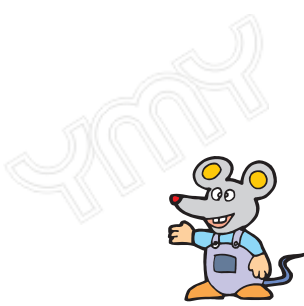
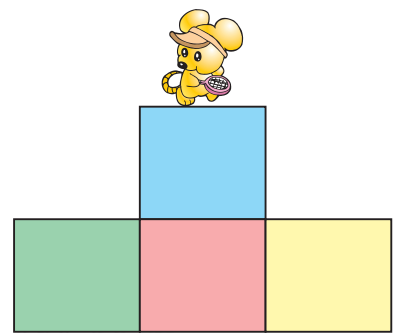
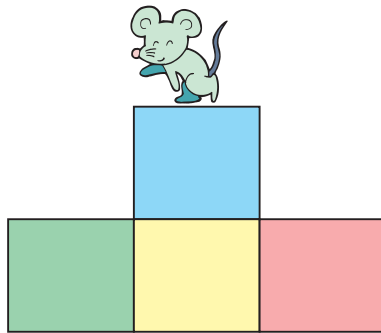
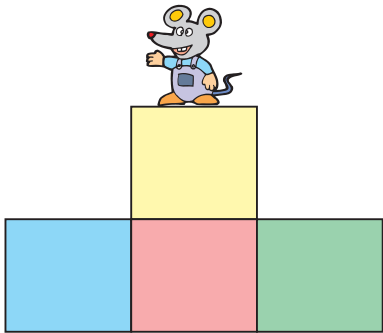

A maze puzzle for counting practice. A yellow and orange dinosaur is at the start of the maze. The maze has four paths leading to boxes. The top path contains a lemon and a box with the number 2. The middle path contains a watermelon slice and an empty box. The bottom path contains a banana and a milk carton, and an empty box. The left path contains an apple and an empty box. The bottom path contains a hamburger and an empty box.

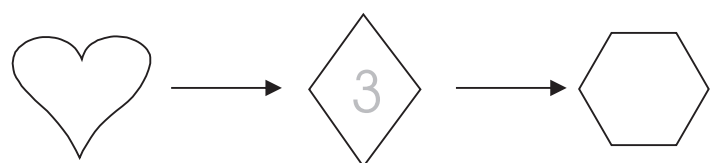
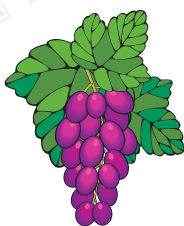
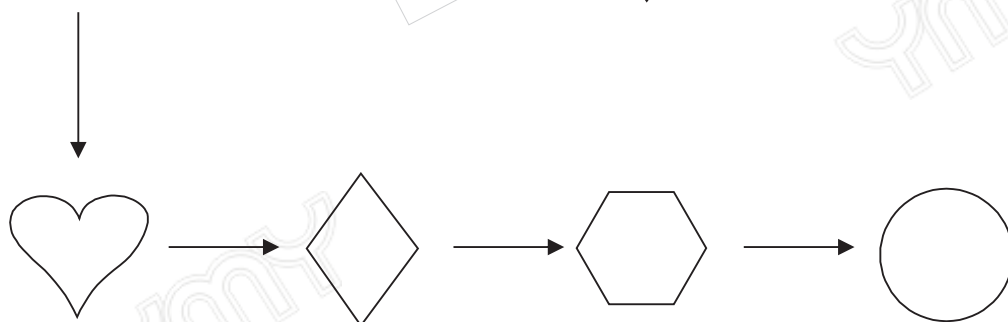
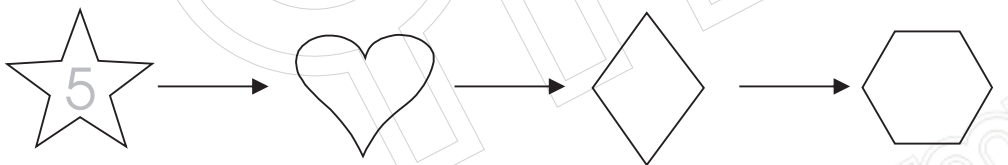
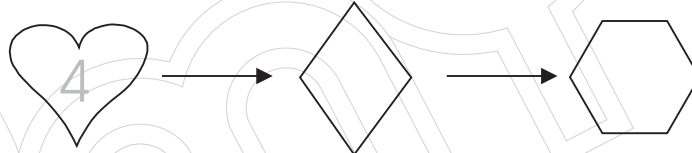
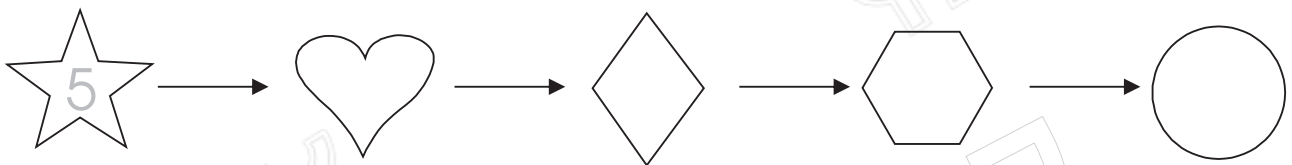
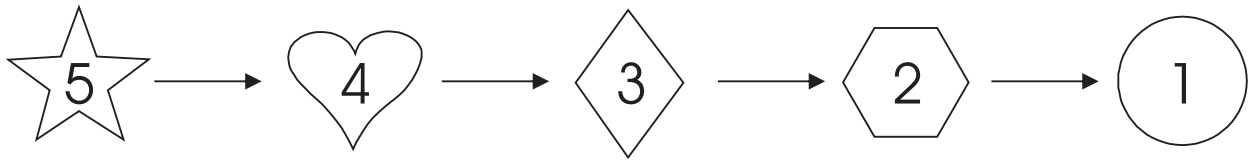

3 ○ ○ ○ ○ ○

5 ○ ○ ○ ○ ○

4 → ○ ○ ○ ○ ○

1 ○ ○ ○ ○ ○

2 ○ ● ○ ○ ○



(2) () () () ()

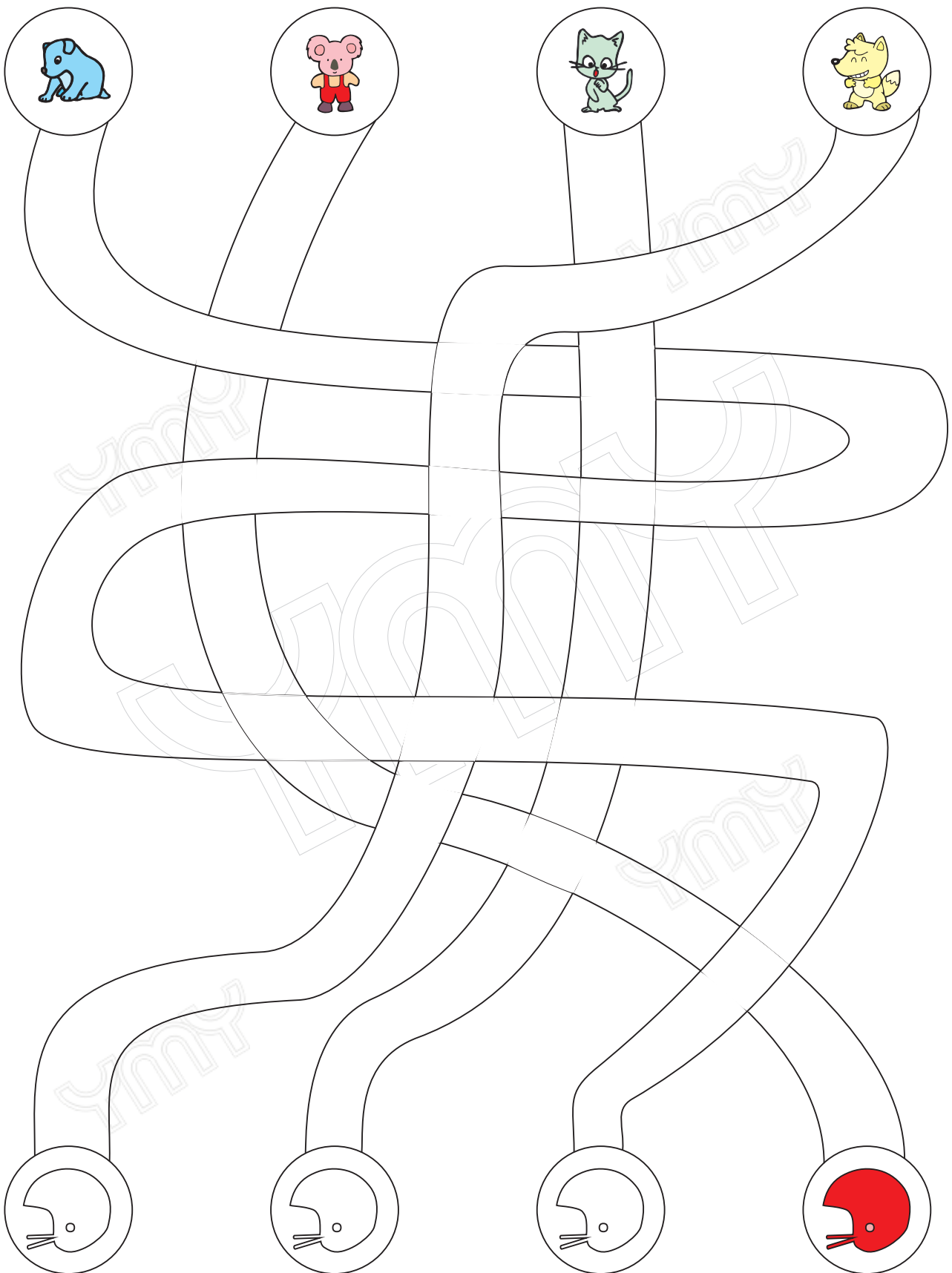

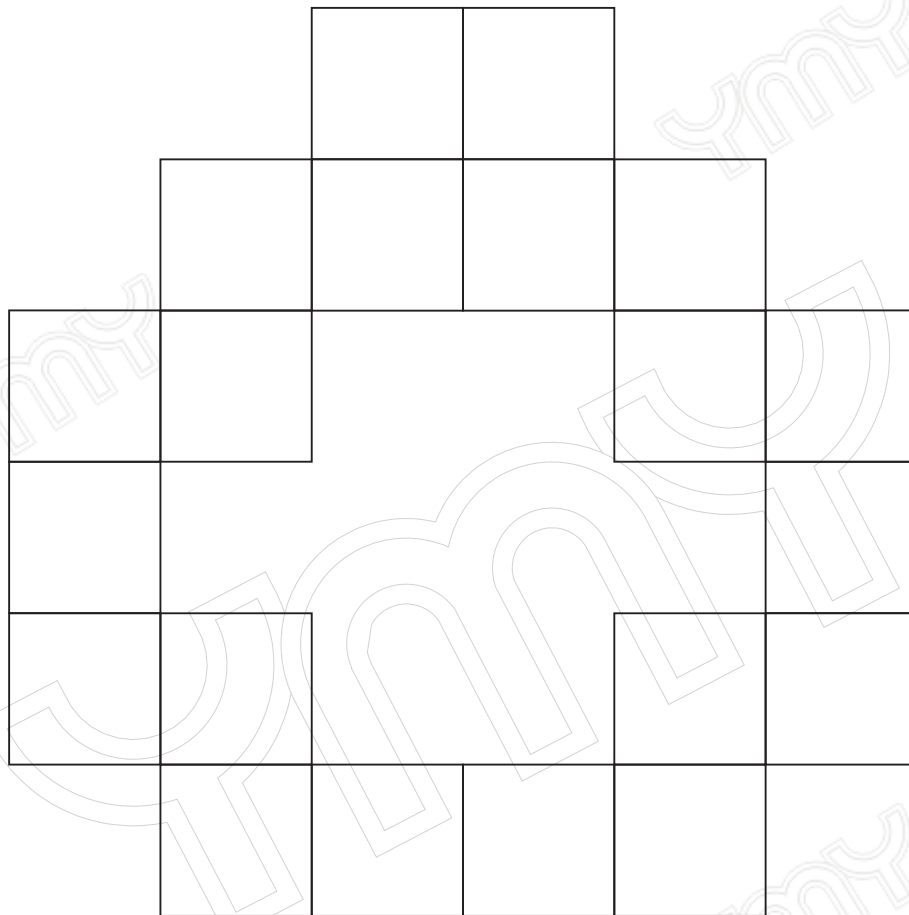
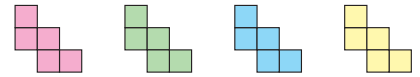

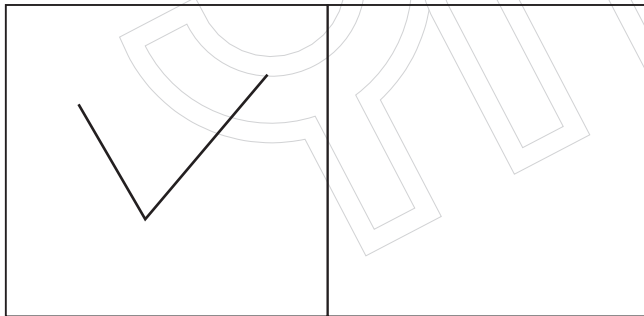
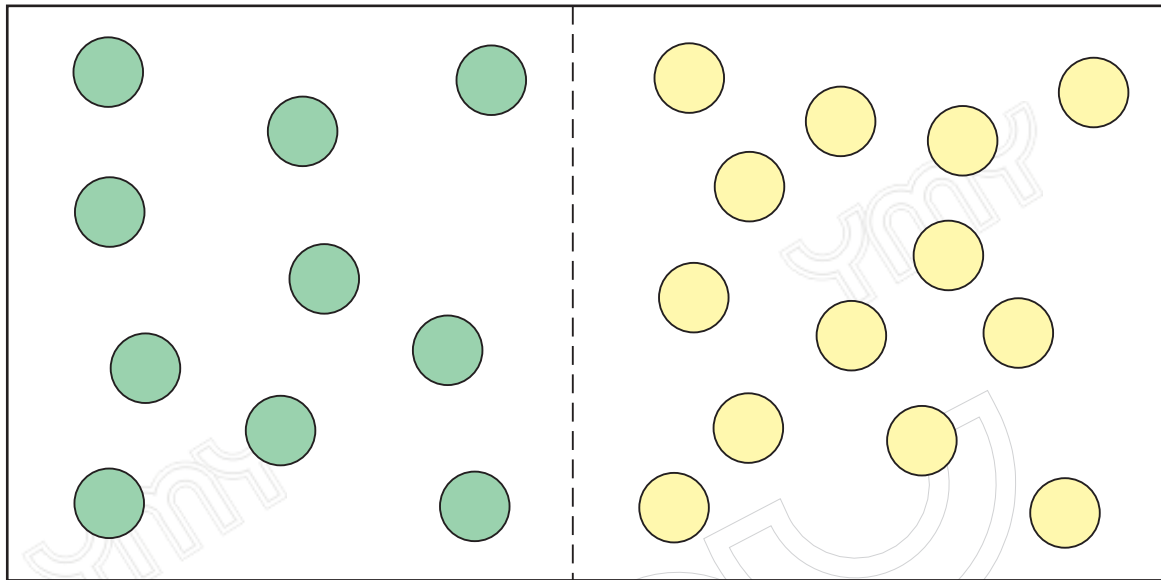

☁ ()

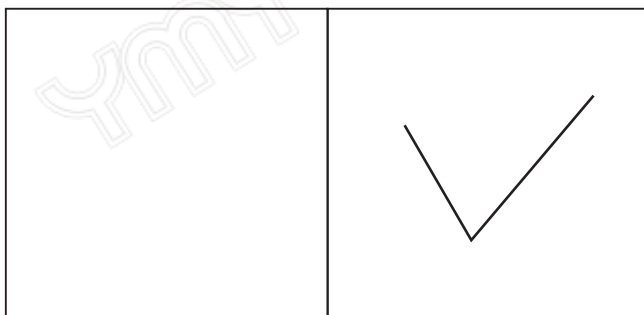

☁ ()

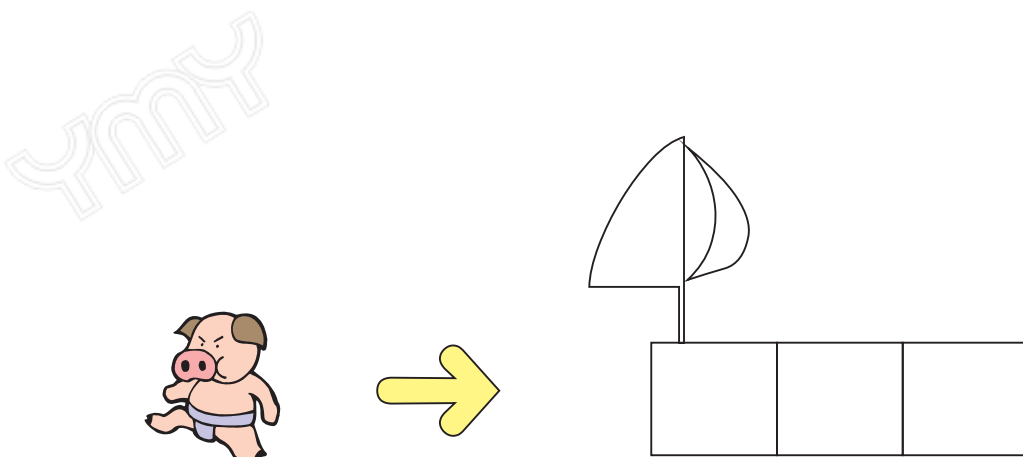
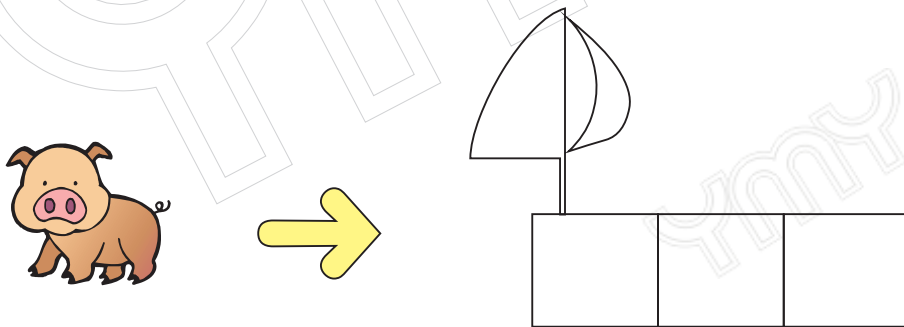
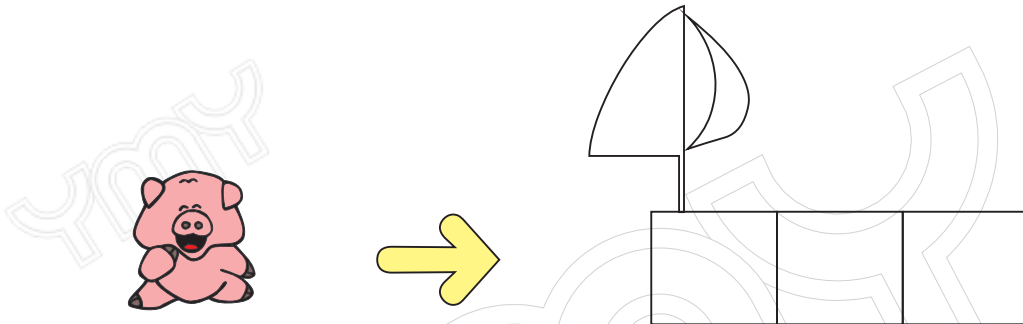
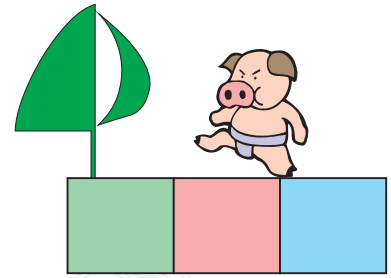
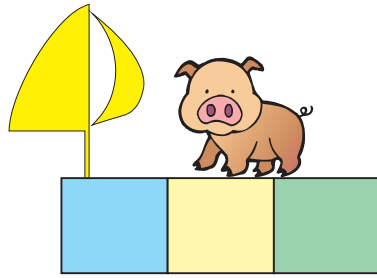
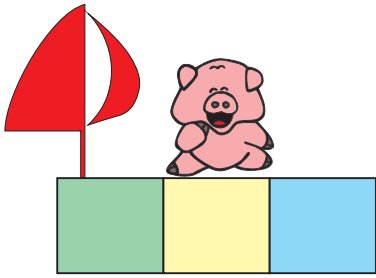



3

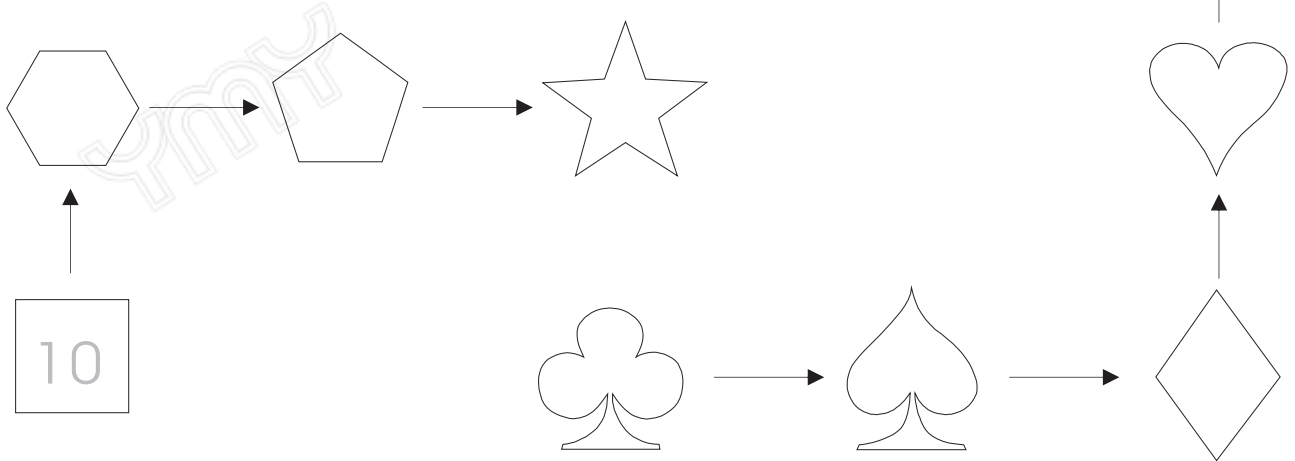
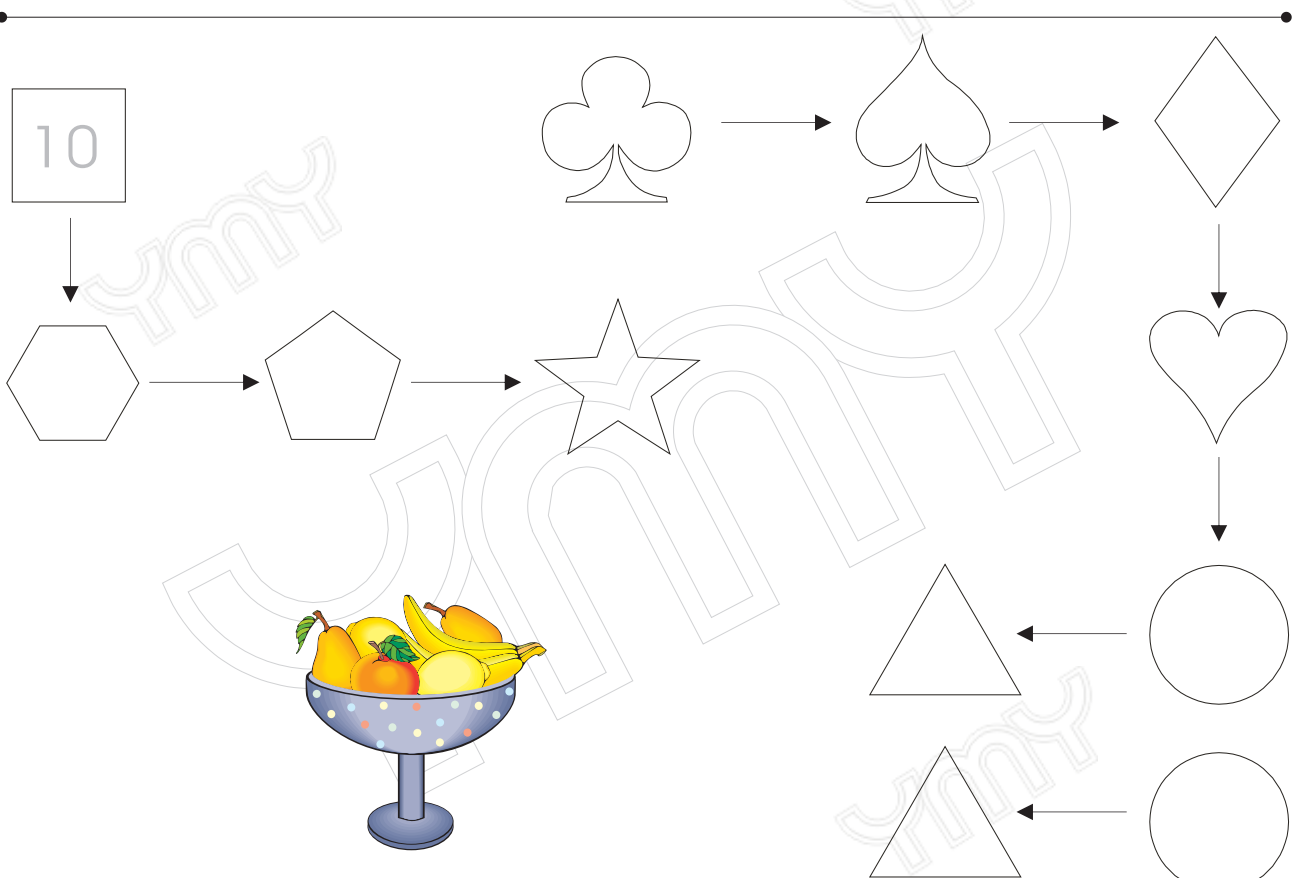
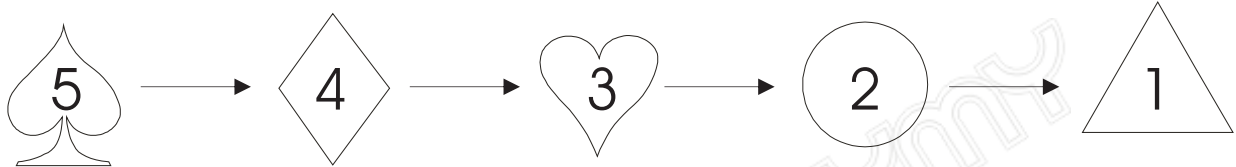
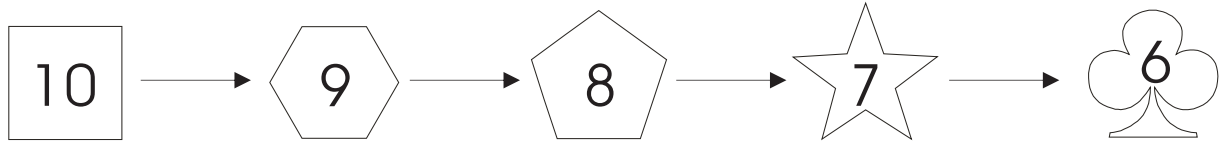

(3)

(5)

(2) →

(1)

(4)

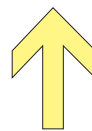
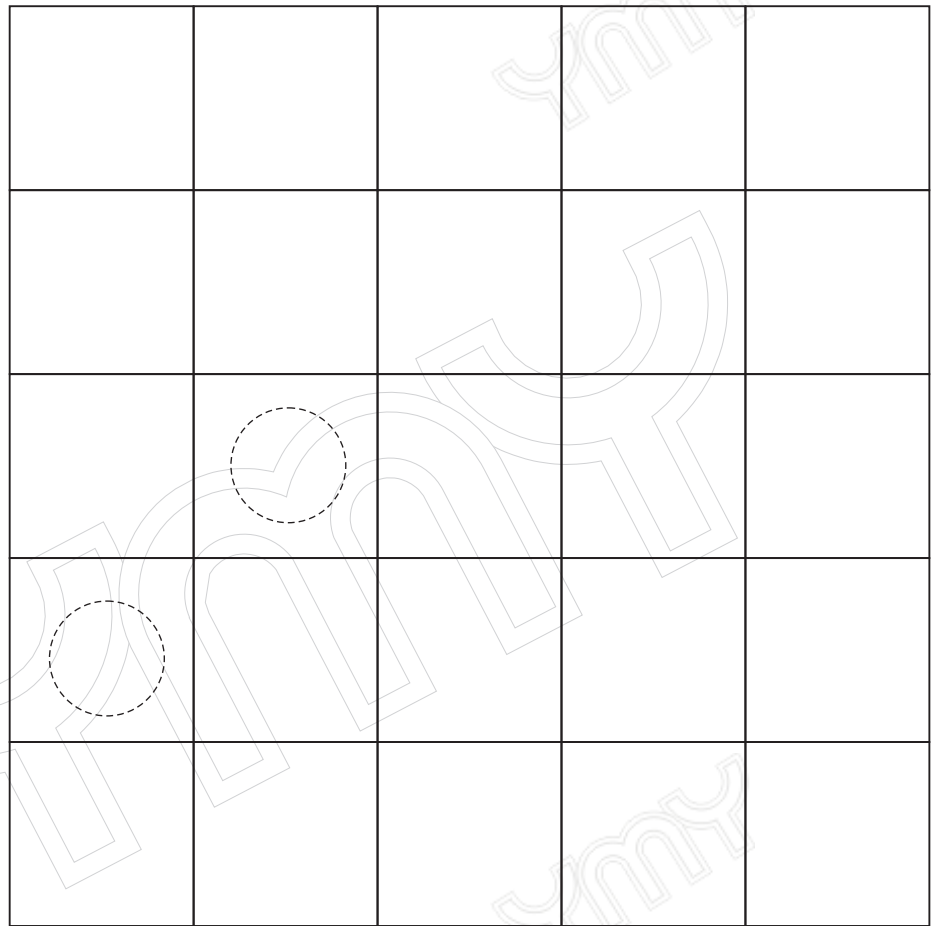

(2) () () () ()



